

Zwischenplatte

T09.820.300.JL

L=45mm, C=15mm, D=30mm, B=2mm

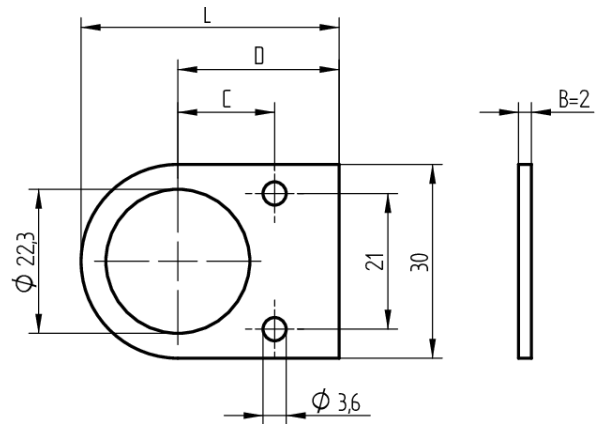
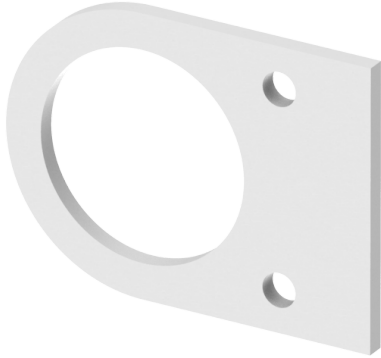

Die Produkte können von den dargestellten Bildern abweichen

Verwendung

für Aufschraub-Riegelschloss zu 05.018.00 / 05.118.00 /
05.418.00 / 05.518.00 / 05.618.00 / 05.718.00

Lieferumfang

- 1 Zwischenplatte

Baugleiche Ausführungen

- T09.820.300.JL - L = 45, C = 15, D = 30, B = 2
- T09.820.350.JL - L = 50, C = 15, D = 35, B = 2
- T09.820.400.JL - L = 55, C = 25, D = 40, B = 2
- T09.820.450.JL - L = 60, C = 25, D = 45, B = 2
- T09.820.500.JL - L = 65, C = 25, D = 50, B = 2

Merkmale

- Länge: 45mm
- Mass C: 15mm
- Mass D: 30mm
- Breite: 2mm

