

Riegel

T09.940.250.27

D=25mm / K=12.5mm

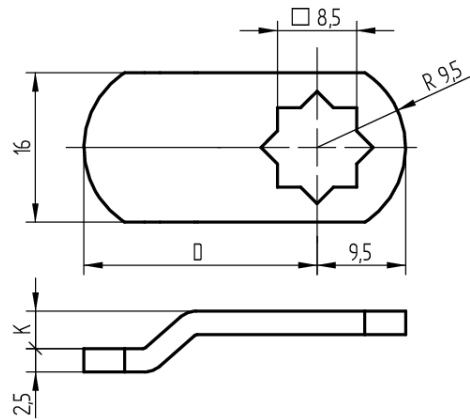
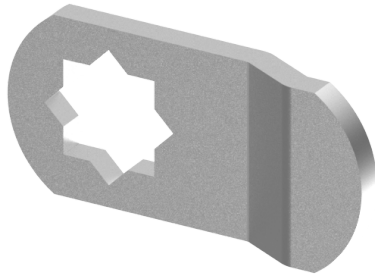

Die Produkte können von den dargestellten Bildern abweichen

Verwendung

Mechanik:

für Möbel- und Apparatezylinder 04.020.VV. / 04.102.VV.
sowie für Verschluss-Zylinder 06.045.VV. / 06.049.VV. /
06.145.VV. /

06.149.VV.

Mechatronik:

für Möbelzylinder

63.001.70.WW.XX.05.ZZ / 63.001.70.WW.XX.07.ZZ /

63.001.71.WW.XX.05.ZZ / 63.001.71.WW.XX.07.ZZ /

63.001.72.WW.XX.05.ZZ / 63.001.72.WW.XX.07.ZZ /

63.001.73.WW.XX.05.ZZ / 63.001.73.WW.XX.07.ZZ /

63.001.75.WW.XX.05.ZZ / 63.001.75.WW.XX.07.ZZ

Lieferumfang

- 1 Riegel

Baugleiche Ausführungen

- T09.920.300.27 - D = 30 / K = 2.5
- T09.920.340.62 - D = 34 / K = 2.5
- T09.920.400.27 - D = 40 / K = 2.5
- T09.920.500.27 - D = 50 / K = 2.5
- T09.925.250.27 - D = 25 / K = 4
- T09.925.300.27 - D = 30 / K = 4
- T09.925.340.27 - D = 34 / K = 4
- T09.925.350.27 - D = 35 / K = 4
- T09.925.400.27 - D = 40 / K = 4
- T09.930.250.27 - D = 25 / K = 7.5
- T09.930.300.27 - D = 30 / K = 7.5
- T09.930.350.27 - D = 35 / K = 7.5
- T09.930.400.27 - D = 40 / K = 7.5
- T09.935.230.27 - D = 23 / K = 8.5
- T09.935.250.27 - D = 25 / K = 8.5
- T09.935.300.27 - D = 30 / K = 8.5
- T09.935.350.27 - D = 35 / K = 8.5
- T09.935.400.27 - D = 40 / K = 8.5
- T09.935.500.27 - D = 50 / K = 8.5

Merkmale

- Art: gekröpfter Riegel
- Mass D (mm): 25
- Mass K (mm): 12.5